

Varenummer: 586PL66

Beskrivelse: Mini Push-in PL66, vinkel, M6 slange Ø6

Mål

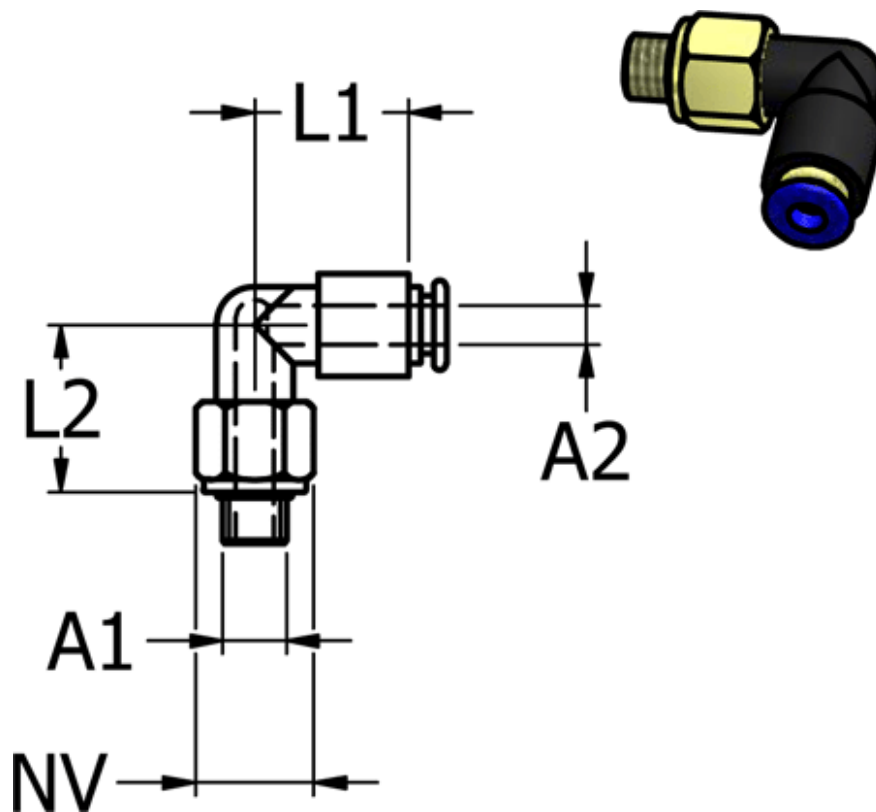

Gevind A1	= M6
L1	= 16
L2	= 17.6
NV	= 10
Udv. slangediamter A2	= 6 mm